

UTS In-line receptacle



Description

A cable-to-cable solution

Intended for cable-to-cable applications, UTS In-line connector guarantees an excellent sealing level rated up to Dynamic IP68/69K.

Applications

UTS In-line receptacles can be used in applications such as:

- Renewable & Portable Energy
- Factory Automation & Control
- Machine Tools / Special Machines
- Robotics
- Building Automation & Control
- Instrumentation / Measurement
- Off-Road
- Lighting
- Signalling
- Stage Light & Sound
- Civil marine

Benefits

Excellent watertightness

- 'O'ring on the rear part of the receptacle
- Dynamic IP68/69K sealing level

Double watertightness

- Seals on backshell & receptacle

Ideal for outdoor / indoor applications

- Plastic shell - corrosion resistance

Easy use in tight-space areas

- Ergonomic design

Easy visual identification & keying

- Colour rings - optional

Intermateability with specific plugs

- Plug with discrete wire sealing or screw contact termination

RoHS compliant

- Respect for environment

SOURIAU's Offer

- Availability: 4 shell sizes, 12 contact layouts
- Other versions: with screw contact termination or with discrete wire sealing

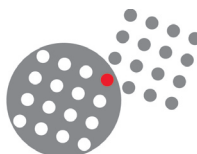
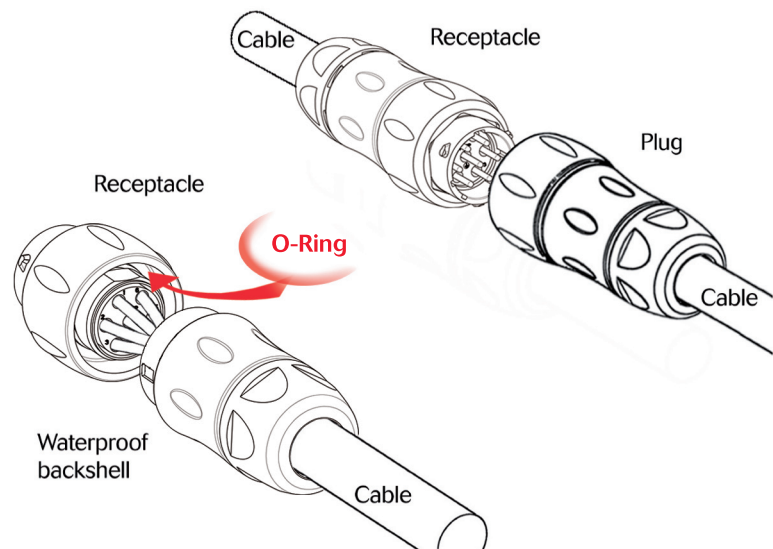

SOURIAU
Connection Technology



UTS In-line receptacle

Technical characteristics

Mechanical

- Durability 250 matings & unmatings
- Vibration resistance per CEI 60512-4
- Thermal shock per MIL-STD1344 method 1003

Electrical

- Insulation resistance 5000 MΩ min.
- Test potential 2000 Vrms
- As per VDE / UL standards - please refer to UTS catalogue page 9

Environmental

- Operating temperature -40°C to + 105°C
- Sealing (mated) Dynamic IP68/69K
IP67 with grommet (up to IP68/69K with easy handling plastic backshell)

- UV resistance No mechanical degradation or important variation of color after 5 years of exposure in natural environment (equivalence exposure to sun & moisture as per ISO 4892)
- Salt spray resistance 500 hours
- Flammability rating UL94V0

Material

- Connectors + Backshell Thermoplastic
- Seal gasket Silicone
- RoHS compliant & conform to the Chinese standard SJ/T 1166-2006 (Chinese RoHS equivalent)



Contact arrangements

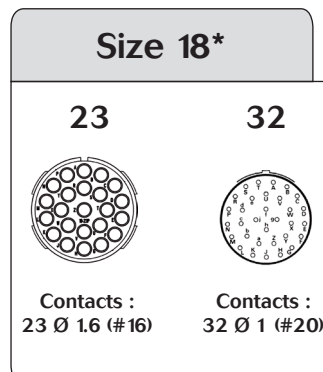
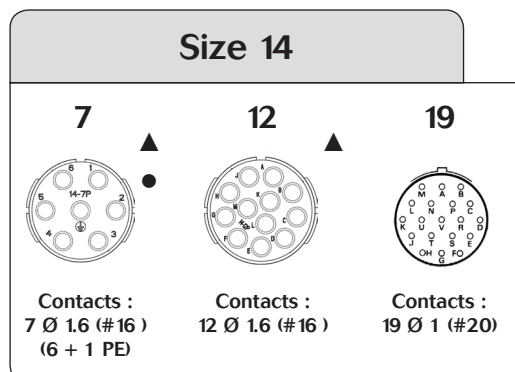
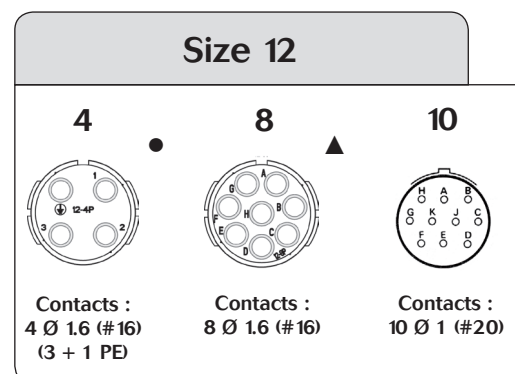
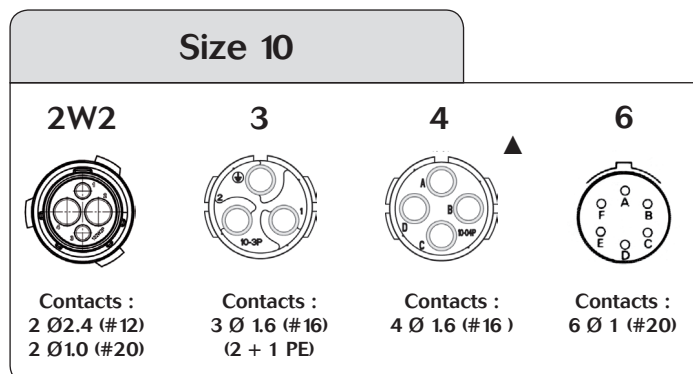

- ▲ UTS In-line version with discrete wire sealing version
- UTS In-line version with screw contact termination

UTS In-line receptacle



Ordering information

Type	UTS	1	JC	12	10	S
Connector type	1 In-line version					
Rear of the connector	JC Easy handling plastic backshell					
Insert arrangement	10 - 12 - 14 - 18*					
Number of contacts	- see Contact arrangement					
Contact Gender	P: Male contact / S: Female contact					

* Please consult factory for shell size 18

Range presentation

Standard In-line receptacle - Easy handling backshell

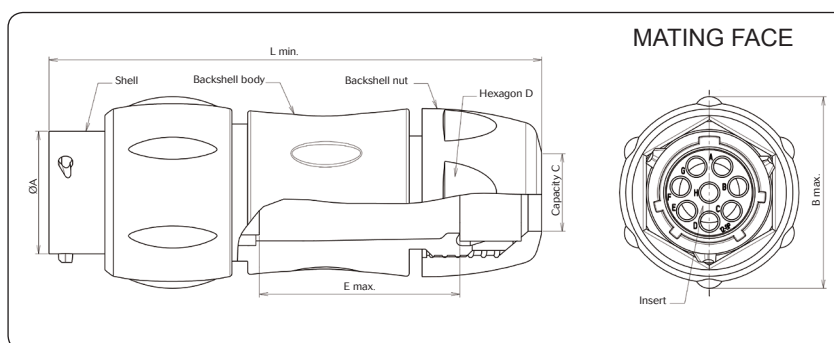

Shell size	Ø A	L min.	Ø B max	E max		Hexagon D	Capacity C Standard seal	Capacity C Reducing seal
				Male	Female			
10	14.9	70.0	26.7	31.0	38.0	18.5	2.5/8.0	1.5/5.0
12	19.0	74.0	30.15	34.0	41.5	24.0	5.0/12.0	3.0/9.0
14	22.2	78.5	35.1	38.0	45.5	26.0	7.0/14.0	5.0/12.0
18*	28.5	89.0	42.0	46.5	54.0	33.0	9.0/18.0	7.0/16.0

*For shell size 18, please consult us

Contacts & coloured rings are to be ordered separately, except screw termination contact - please refer to the UTS catalogue.



UTS In-line receptacle

In-line receptacle with screw contact termination - Easy handling backshell

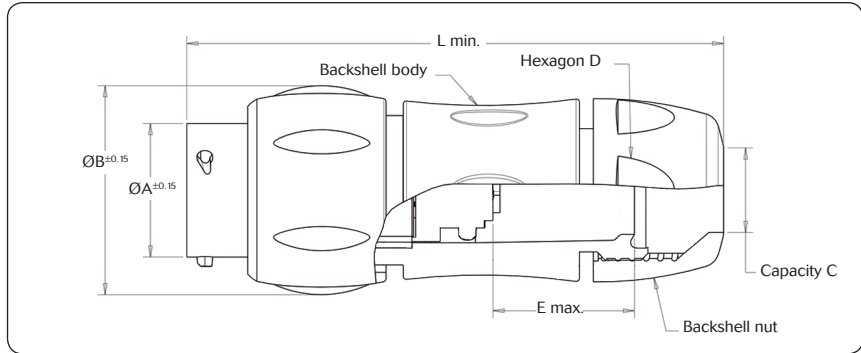

Shell size	Layout	PN male contacts	Ø A	L min.	Ø B max.	E max.	Hexagon D	Capacity C Standard seal	Capacity C Reducing seal
12	12-4	UTS1124PSCR	19.0	74.0	29.7	21.5	24.0	5.0 / 12.0	3.0 / 9.0
14	14-7	UTS1147PSCR	22.2	78.5	34.6	26.5	26.0	7.0 / 14.0	5.0 / 12.0

In-line receptacle with discrete wire sealing - Easy handling backshell

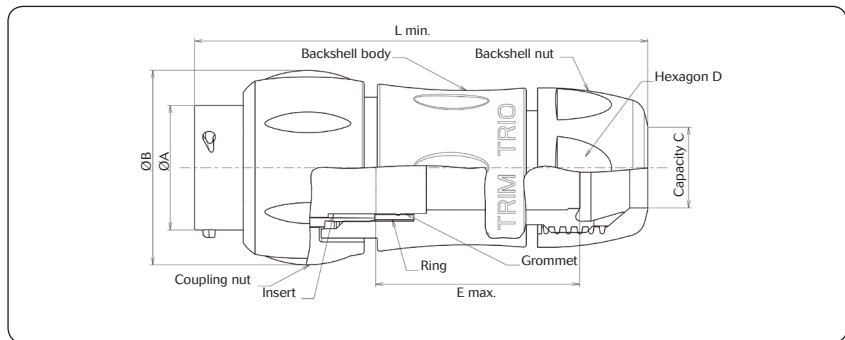

Shell size	Layout	PN Female contact	Ø A	L min.	Ø B max.	E max.	Hexagon D	Capacity C Standard seal	Capacity C Reducing seal	Wire insulation
10	10-4	UTS1GJC104S	14.90	70.50	26.20	30.00	27.00	2.5 / 8	1.5 / 5	Ø from 1.7 mm to 3.0 mm
12	12-8	UTS1GJC128S	19.00	74.00	29.70	33.50	31.80	5 / 12	3 / 9	
14	14-7 14-12	UTS1GJC147S UTS1GJC1412S	22.20	80.50	34.60	37.60	34.90	7 / 14	5 / 12	



UTS In-line receptacle

In-line receptacle with discrete wire sealing - Short backshell

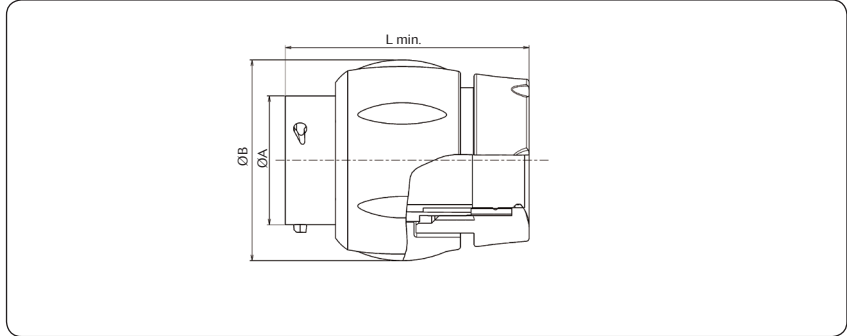

Shell size	Layout	PN Female contact	Ø A	L min.	Ø B	Wire insulation
10	10-4	LTS1GN104S	14.90	40.90	26.20	Ø from 1.7 mm to 3.0 mm
12	12-8	LTS1GN128S	19.00	40.90	29.70	
14	14-7 14-12	LTS1GN147S LTS1GN1412S	22.20	43.00	34.60	

SOURIAU INDUSTRIAL WEBTOOLS
 IN EXCLUSIVITY FOR TRIM TRIO® PRODUCT RANGE
www.souriau-industrial.com
NEW WEBSITE & SMART CONFIGURATION TOOLS

In less than 5 minutes:
 - compose a part number
 - get a 2D drawing

For further information, visit our website www.souriau-industrial.com or contact us at contactindustry@souriau.com

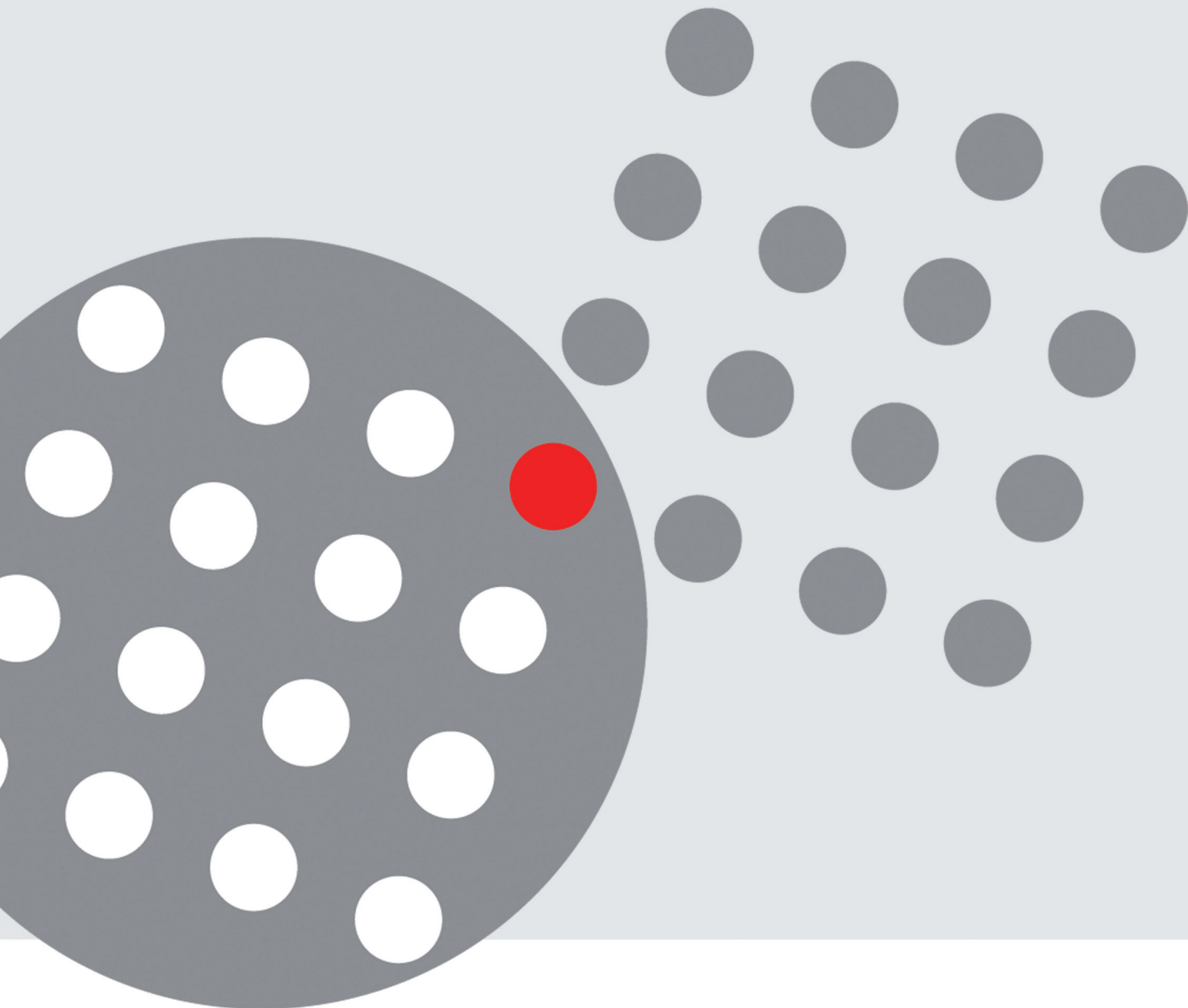

www.souriau.com
contactindustry@souriau.com

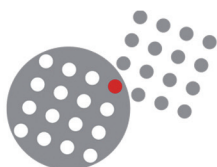

SOURIAU
Connection Technology