

Right Angle Shapes, VG style

- Helashrink 1100 Series, with rib

This style provides strain relief for harness systems when used in conjunction with a circular grooved adaptor. For VG shapes with portholes "P" please refer to product standards tables in the appendix.



1152-4-G recovered onto a connector.



1155-4 supplied.

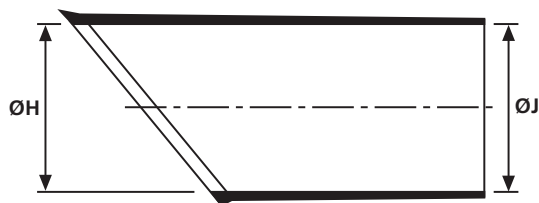

a: Expanded form (supplied)

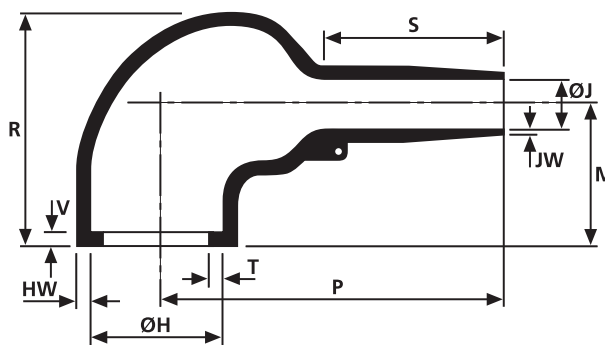

b: Fully recovered form (after heating)

Sizes and Type Table

Type	Designation as per VG-Norm	ØH min. a	ØH max. b	ØJ min. a	ØJ max. b	P ± 10%	R ± 10%	HW ± 20%	JW ± 20%	V ± 10%	T ± 20%	M nom	S nom
1152-4	VG95343T06E001A	24.0	10.5	24.0	6.0	26.0	25.0	1.3	0.5	3.0	1.0	19.0	10.0
1154-4	VG95343T06E002A	30.0	15.5	30.0	6.0	32.0	27.0	1.5	0.8	3.0	1.0	19.0	12.0
1155-4	VG95343T06E003A	31.0	18.0	31.0	7.0	40.0	31.0	1.8	1.0	3.0	1.0	21.0	15.0
1156-4	VG95343T06E004A	36.0	22.5	36.0	8.5	46.0	38.0	1.8	1.0	3.0	1.0	26.0	15.0
1157-4	VG95343T06E005A	43.0	28.5	43.0	10.0	55.0	45.0	2.0	1.0	3.0	1.7	30.0	16.0
1158-4	VG95343T06E006A	60.0	35.0	60.0	16.0	80.0	54.0	3.3	1.5	3.0	1.7	35.0	30.0
1159-4	VG95343T06E007A	66.0	45.0	66.0	17.0	108.0	68.0	3.8	2.0	3.0	2.0	42.0	51.0
1160-4	VG95343T06E008A	82.0	61.0	82.0	25.0	118.0	84.0	4.0	4.0	3.0	2.0	52.0	39.0

All dimensions in mm. Subject to technical changes.

Combinations "On request"

Adhesive	Material					
	B7	G	J	H	B8	L
WM250	√	√	√	√	√	-
W8	√	√	√	√	-	-
W24	√	√	√	√	-	√
V9500	√	√	√	√	-	-
HMT200A	√	√	√	√	√	-
W21	-	-	√	√	-	-
Without Adhesive	√	√	√	√	√	√

Standard combinations

Article-No.	Type
411-52480	1152-4-G
411-54480	1154-4-G
411-55480	1155-4-G
411-56480	1156-4-G
411-57480	1157-4-G
411-58480	1158-4-G
411-59480	1159-4-G
411-60480	1160-4-G

Right Angle Shapes, VG style

- Helashrink 1100 Series, without rib, thick wall

This style provides connector cable strain relief. Can be installed on the connector rear thread or plain shaft, allows easy re-entry for repair when combined with a hot melt adhesive.



1114-1 supplied / fully recovered.

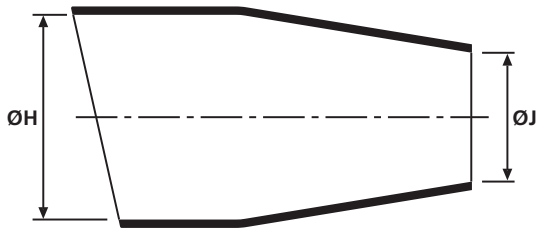

a: Expanded form (supplied)

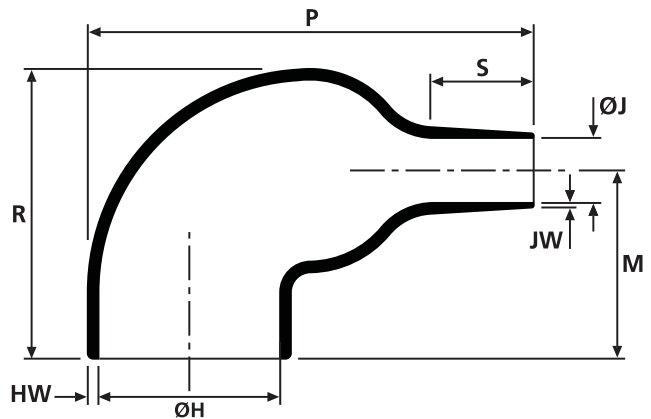

b: Fully recovered form (after heating)

Sizes and Type Table

Type	Designation as per VG-Norm	ØH min. a	ØH max. b	ØJ min. a	ØJ max. b	P ±20%	R ± 10%	HW ± 30%	JW ± 30%	M nom	S nom
1113-1	VG95343T063003A	19.0	14.5	8.0	4.5	39.0	26.0	2.5	1.8	19.0	8.0
1114-1	VG95343T063004A	23.5	18.0	11.5	5.5	51.0	33.0	3.0	1.0	22.0	9.5
1118-1	VG95343T063008A	59.0	45.0	44.0	21.0	133.0	73.0	7.0	5.0	45.0	40.0

All dimensions in mm. Subject to technical changes.

For Material / Adhesive selection and other information please refer to page 10.

Combinations "On request"

Adhesive	Material			
	B7	G	J	H
WM250	√	√	√	√
W8	√	√	√	√
W24	√	√	√	√
V9500	√	√	√	√
HMT200A	√	√	√	√
W21	-	-	-	√
Without Adhesive	√	√	√	√

Standard combinations

Article-No.	Type
411-13002	1113-1-G
411-14004	1114-1-G
411-18001	1118-1-B7

Right Angle Shapes, MIL style

- Helashrink 1100 Series, with rib

This style provides strain relief for harness systems when used in conjunction with circular grooved adaptor.



1108-4 supplied / fully recovered

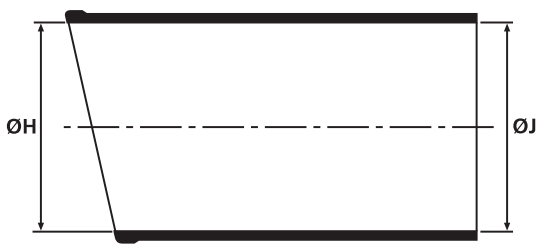

a: Expanded form (supplied)

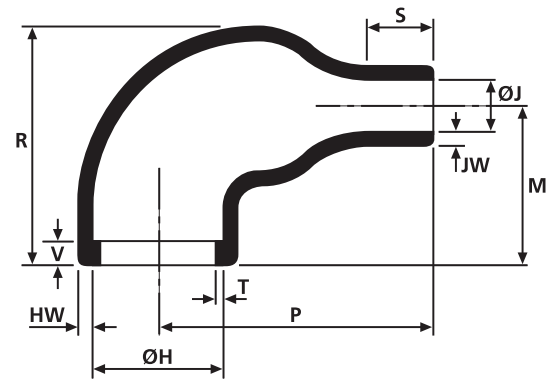

b: Fully recovered form (after heating)

Sizes and Type Table												
Type	ØH min. a	ØH max. b	ØJ min. a	ØJ max. b	P ± 10%	R ± 10%	HW ± 20%	JW ± 30%	V max	T ± 20%	M nom	S nom
1181-4	12.0	9.8	6.0	2.0	19.0	13.0	1.0	0.5	1.5	0.6	11.0	6.0
1108-4	16.5	7.9	16.5	2.5	18.3	20.1	1.0	1.6	3.3	1.0	15.2	5.1
1106-4	23.3	10.4	23.3	5.6	20.3	22.9	1.3	1.3	3.3	1.0	15.2	5.8
1107-4	28.4	14.2	28.4	6.3	29.8	28.5	1.5	1.5	3.3	1.0	21.4	7.1
1104-4	30.9	17.8	30.9	7.1	35.6	30.5	1.8	1.8	3.3	1.0	20.6	8.6
1103-4	36.0	22.4	36.0	8.4	43.2	35.6	1.8	1.8	3.3	1.0	22.9	12.7
1101-4	42.6	27.9	42.6	9.7	53.3	43.2	2.0	2.0	3.3	1.7	27.9	15.7
1105-4	51.8	35.1	51.8	15.7	78.7	53.3	3.3	3.3	3.3	1.7	33.0	30.5

All dimensions in mm. Subject to technical changes.

Combinations "On request"					
Adhesive	Material				
	B7	G	J	H	L
WM250	√	√	√	√	-
W8	√	√	√	√	-
W24	√	√	√	√	√
V9500	√	√	√	-	-
HMT200A	√	√	√	√	-
Without Adhesive	√	√	√	√	-

Standard combinations	
Article-No.	Type
411-81480	1181-4-G
411-08015	1108-4-B7
411-06019	1106-4-G
411-07020	1107-4-G
411-04032	1104-4-G
411-03024	1103-4-G
411-01020	1101-4-G
411-05019	1105-4-J

Right Angle Shapes

- Helashrink 1100 Series, without rib

This style provides connector cable strain relief. Can be installed on the connector rear thread or plain shaft, allows easy re-entry for repair when combined with a hot melt adhesive.



1108-1 supplied / fully recovered.



a: Expanded form (supplied)

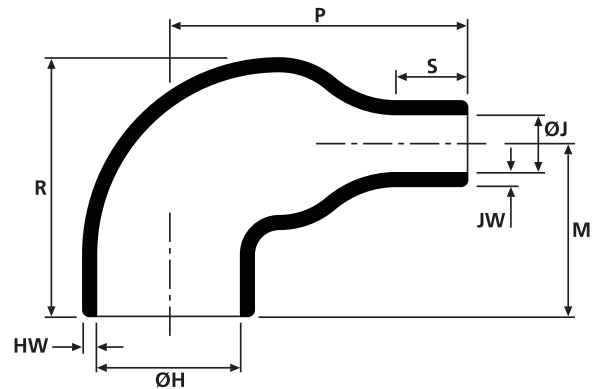

b: Fully recovered form (after heating)

For Material / Adhesive selection and other information please refer to page 10.

Standard combinations

Article-No.	Type
411-08002	1108-1-B7
411-08011	1108-2-G
411-06003	1106-1-G
411-06051	1106-2-B7
411-07004	1107-1-G
411-07011	1107-2-G
411-04005	1104-1-G
411-04013	1104-2-G
411-03003	1103-1-G
411-03012	1103-2-G
411-01005	1101-1-G
411-01029	1101-1-GW8
411-05005	1105-1-G
411-05010	1105-2-G
411-09004	1109-1-G
411-00001	1100-4-G

Sizes and Type Table

Type	ØH		ØJ		P		R		HW		JW		S nom	M nom
	min. a	max. b	min. a	max. b	± 10%	± 10%	± 20%	± 30%						
1108-1	16.5	7.9	16.5	2.5	18.3	20.1	1.0	1.6	5.1	15.2				
1108-2	10.6	7.9	8.3	2.5	18.3	20.1	1.0	1.6	5.1	15.2				
1106-1	23.6	10.4	23.6	5.6	20.3	22.9	1.3	1.3	5.8	15.2				
1106-2	13.7	10.4	11.6	5.6	20.3	22.9	1.3	1.3	5.8	15.2				
1107-1	28.4	14.2	28.4	6.3	29.8	28.5	1.5	1.5	7.1	18.5				
1107-2	19.3	14.2	14.2	6.3	29.8	28.5	1.5	1.5	7.1	18.5				
1104-1	24.1	17.8	15.7	7.1	35.6	30.5	1.8	1.8	8.6	20.6				
1104-2	31.7	17.8	31.7	7.1	35.6	30.5	1.8	1.8	8.6	20.6				
1103-1	38.1	22.4	38.1	8.4	43.2	35.6	1.8	1.8	12.7	22.9				
1103-2	30.4	22.4	19.0	8.4	43.2	35.6	1.8	1.8	12.7	22.9				
1101-1	43.1	27.9	43.1	9.7	53.3	43.2	2.0	2.0	15.7	27.9				
1101-2	38.1	27.9	22.8	9.7	53.3	43.2	2.0	2.0	15.7	27.9				
1105-1	52.3	35.1	52.3	15.7	78.7	53.5	3.3	3.3	30.5	33.0				
1105-2	46.9	35.1	35.3	15.7	78.7	53.5	3.3	3.3	30.5	33.0				
1109-1	66.0	44.5	66.0	20.3	97.5	66.0	3.8	3.8	40.6	41.7				
1100-4	26.0	15.5	16.0	4.0	25.0	17.0	1.8	1.0	20.0	17.0				

All dimensions in mm. Subject to technical changes.

Combinations "On request"

Adhesive	Material				
	B7	G	J	H	L
WM250	√	√	√	√	-
W8	√	√	√	√	-
W24	√	√	√	√	√
V9500	√	√	√	√	-
HMT200A	√	√	√	√	-
W21	-	-	-	√	-
Without Adhesive	√	√	√	√	√

Right Angle Shapes, VG style/MIL style

- Helashrink 1100 Series, with rib, low profile

This style is typically used on airborne harnesses to achieve light weight, low profile, compact strain relief and mechanical protection.



1123-1-G supplied / fully recovered.



a: Expanded form (supplied)

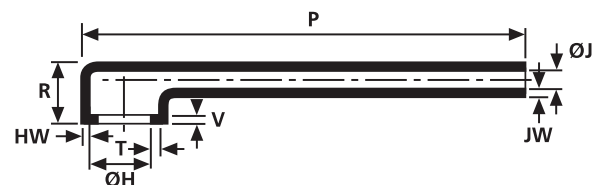

b: Fully recovered form (after heating)

Sizes and Type Table

Type	Designation as per VG-Norm	ØH min. a	ØH max. b	ØJ min. a	ØJ max. b	P ± 10%	R ± 10%	HW ± 20%	JW ± 30%	T ± 10%	V ± 10%
1121-1	VG95343T06F001A	22.0	12.0	22.0	6.5	70.0	19.0	1.5	1.1	1.0	3.0
1122-1	VG95343T06F002A	25.5	15.0	25.0	7.5	79.0	20.0	1.5	1.1	1.0	3.0
1123-1	VG95343T06F003A	29.0	19.0	29.0	8.5	89.0	21.0	1.8	1.1	1.0	3.0
1124-1	VG95343T06F004A	34.0	23.0	34.0	10.0	102.0	22.0	1.8	1.1	1.0	3.0
1125-1	VG95343T06F005A	37.0	30.0	37.0	11.0	108.0	24.0	2.0	1.1	1.7	3.0
1126-1	VG95343T06F006A	43.5	34.0	43.5	12.0	121.0	27.0	2.0	1.1	1.7	3.0
1127-1	VG95343T06F007A	50.0	41.5	50.0	14.5	132.0	30.0	2.3	1.4	1.7	3.0
1128-1	VG95343T06F008A	62.5	47.0	62.5	18.0	133.0	33.0	2.5	1.4	2.0	3.0
1129-1	VG95343T06F009A	69.0	60.0	69.0	20.0	137.0	35.0	2.5	1.4	2.0	3.0
1141-1	VG95343T06F010A	82.0	67.0	82.0	23.0	140.0	45.0	2.5	1.4	2.0	3.0
1121-4	–	22.3	11.4	22.3	6.4	105.2	18.5	1.5	1.1	1.0	3.3
1122-4	–	25.6	15.0	25.6	7.5	124.0	19.8	1.5	1.1	1.0	3.3
1123-4	–	29.4	19.0	29.4	8.5	146.3	20.8	1.8	1.1	1.0	3.3
1124-4	–	34.0	22.9	34.0	10.0	172.2	21.8	1.8	1.1	1.0	3.3
1125-4	–	29.5	37.3	37.3	11.0	185.2	24.4	2.0	1.1	1.7	3.3
1125-2	–	41.2	29.5	41.2	11.0	82.0	24.4	2.0	1.1	1.7	3.3
1126-4	–	43.7	34.0	43.7	12.0	213.6	27.0	2.0	1.1	1.7	3.3
1127-4	–	50.0	41.1	2.3	14.5	224.5	9.5	2.3	1.4	1.7	3.3
1127-3	–	50.0	41.1	2.3	14.5	65.0	29.5	2.3	1.4	1.7	3.3
1128-4	–	62.7	47.0	62.7	18.0	227.3	33.3	2.5	1.4	2.0	3.3
1129-4	–	69.3	59.7	69.3	20.0	233.4	35.1	2.5	1.4	2.0	3.3

All dimensions in mm. Subject to technical changes.

**Right Angle Shapes,
VG style/MIL style**

- Helashrink 1100 Series, with rib, low profile



1123-1-G supplied / fully recovered.

Combinations "On request"

Adhesive	Material				
	B7	G	J	H	L
WM250	√	√	√	√	-
W8	√	√	√	√	-
W24	√	√	√	√	√
V9500	√	√	√	√	-
HMT200A	√	√	√	√	-
W21	-	-	-	√	-
Without Adhesive	√	√	√	√	√

Standard combinations

Article-No.	Type
411-21180	1121-1-G
411-22180	1122-1-G
411-23180	1123-1-G
411-24180	1124-1-G
411-25180	1125-1-G
411-26180	1126-1-G
411-27180	1127-1-G
411-28180	1128-1-G
411-29180	1129-1-G
411-41180	1141-1-G
411-21007	1121-4-G
411-22015	1122-4-G
411-23013	1123-4-G
411-24009	1124-4-G
411-25008	1125-4-G
411-25027	1125-2-G
411-26008	1126-4-G
411-27008	1127-4-G
411-27005	1127-3-B7
411-28002	1128-4-G
411-29001	1129-4-J

For Material / Adhesive selection and other information please refer to page 10.

Right Angle Shapes, VG style

- Helashrink 1100 Series, with rib, low profile, high ratio

This style provides connector cable strain relief. Used in applications for partially loaded connectors with small cable diameters. The tail is designed to allow easy orientation prior to cooling.



1135-1-G supplied / fully recovered.

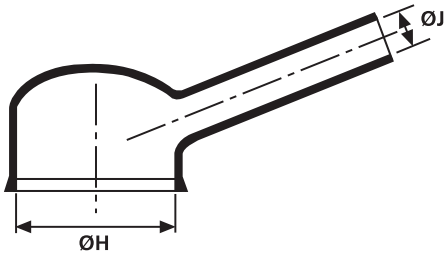

a: Expanded form (supplied)

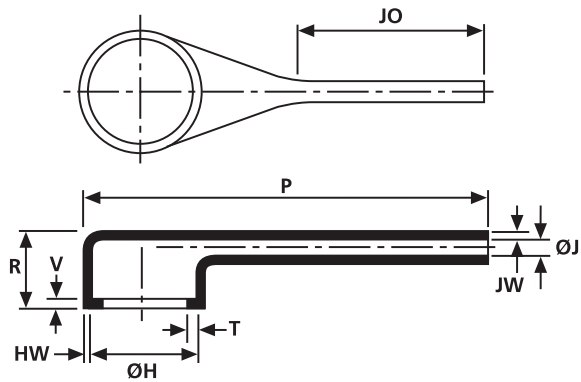

b: Fully recovered form (after heating)

Sizes and Type Table												
Type	Designation as per VG-Norm	ØH	ØH	ØJ	ØJ	P	R	HW	JW	JO	V	T
		min. a	max. b	min. a	max. b	± 10%	± 10%	± 20%	± 20%	± 10%	± 10%	± 20%
1133-1	VG95343T06F011A	19.0	13.0	6.0	2.0	44.0	16.3	1.5	1.1	21.8	3.0	1.0
1133-2	-	19.0	13.0	6.0	2.0	30.0	16.0	1.5	1.1	1.0	3.3	1.0
1134-1	VG95343T18H001A	26.0	19.0	7.5	2.5	67.0	18.0	1.8	1.1	29.2	3.0	1.0
1135-1	VG95343T06F013A	34.0	26.0	9.5	3.0	81.0	18.8	1.8	1.1	35.3	3.0	1.0
1135-1	VG95343T06F013A	34.0	26.0	9.5	3.0	81.0	18.8	1.8	1.1	35.3	3.0	1.0
1136-1	VG95343T06F014A	43.5	34.0	11.5	3.5	116.0	21.3	1.8	1.1	47.0	3.0	1.7
1182-4	-	12.0	7.6	6.0	2.0	16.8	13.0	1.0	0.5	6.0	1.5	0.3

All dimensions in mm. Subject to technical changes.

Combinations "On request"					
Adhesive	Material				
	B7	G	J	H	L
WM250	√	√	√	√	-
W8	√	√	√	√	-
W24	√	√	√	√	√
V9500	√	√	√	√	-
HMT200A	√	√	√	√	-
W21	-	-	-	√	-
Without Adhesive	√	√	√	√	√

Standard combinations	
Article-No.	Type
411-33180	1133-1-G
411-33011	1133-2-G
411-34180	1134-1-G
411-35180	1135-1-G
411-35180	1135-1-G
411-36180	1136-1-G
411-82001	1182-4-G